

## Product Specifications

Viewable Graphic Size: 120.5" w x 91.75" h  
 Graphic Finishing: CMYK Fabric print  
 Hardware Color: Silver  
 Footprint Dimensions: 123.75" w x 13.75" d x 93" h  
 Graphic Template Available

## Product Parts

- 1 - Corners (x2)
- 2 - Foot (x2)
- 3 - Fabric Graphic (x1)
- 4 - Vertical Shock Cord Pole (x2)
- 5 - Horizontal Shock Cord Pole (x2)

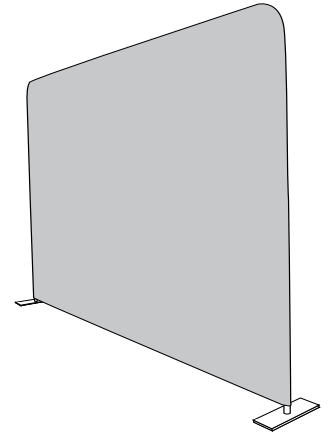
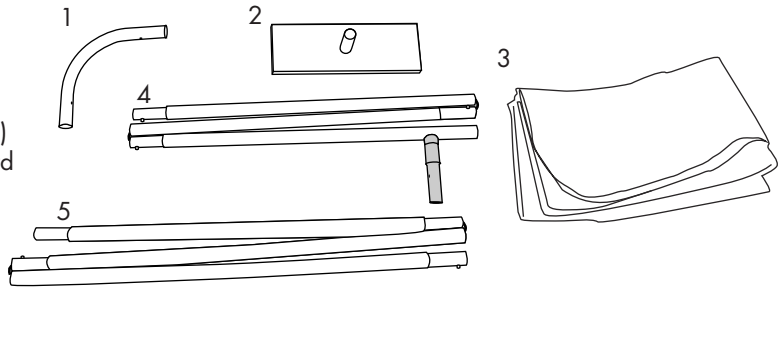

## Display Set-Up

### Step 1

Begin by removing all parts from the carry case and place on a clean, flat surface.

### Step 3

Connect the frame pieces together following the # patterns supplied on the pole pieces. Note that the Vertical Shock Cord Poles have a plastic post that is to be placed closest to the feet.

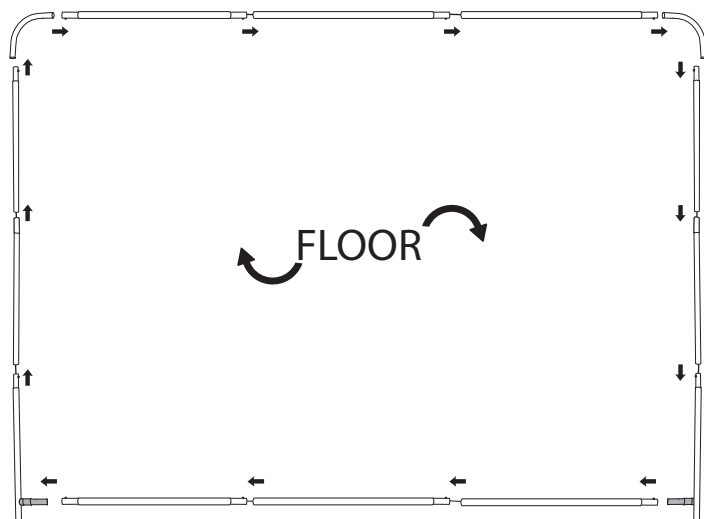

### Step 2

Assemble all poles by placing the tapered end of one pole into the large end of the next while pressing the button snap. Overall frame connection view is shown in Step 3. However, it is best to start assembly with the Vertical Shock Cord Poles (4) and Horizontal Shock Cord Poles (5).

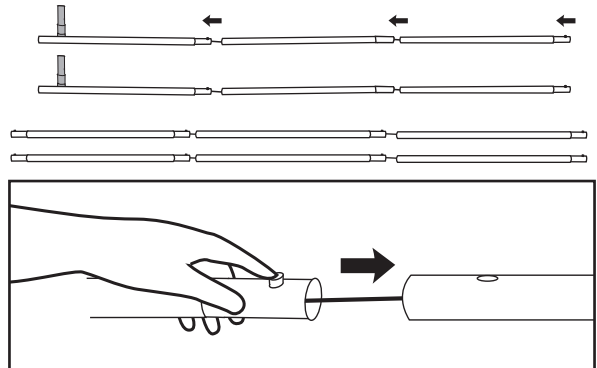

### Step 4

Attach the feet while Frame is still on floor.

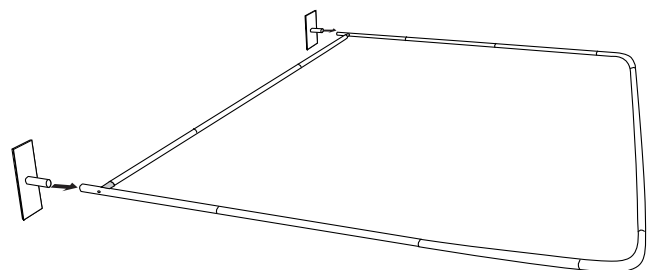

## Display Set-Up Continued...

### Step 5

Slide the Fabric Graphic over the frame.

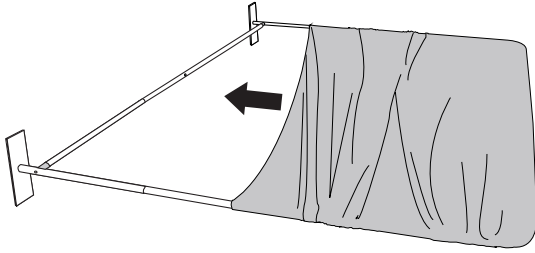

### Step 6

Easily lift the display to a Vertical position.

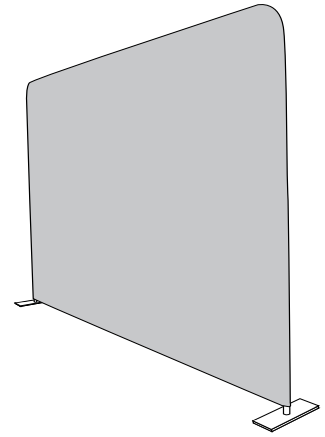

## Display Tear Down

### Step 1

Verify that the floor surface in front of the Display is clean then lay the Display on the floor.

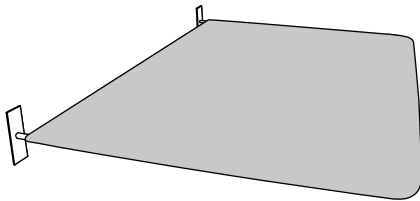

### Step 3

Take apart the frame pieces by pressing the button snap and pull the pieces apart. If the button sticks please push the tube forward while twisting and then pull.

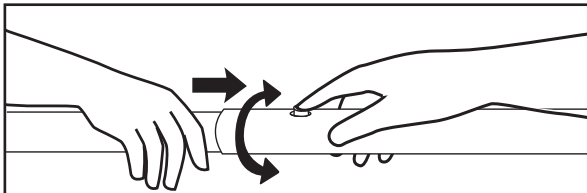

### Step 2

Slide the Fabric Graphic off the Frame, fold and put in case.

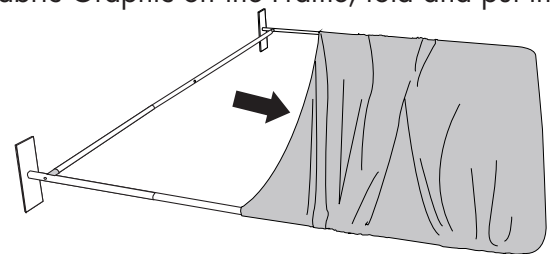

### Step 4

Put all frame pieces into case.

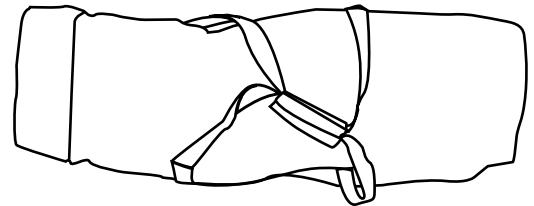

## Storage

Place all product parts into Carry Case and store in a cool dry location.

## Care

Recommended for indoor use only.

Machine wash on gentle cycle using mild detergent. Line Dry. Do NOT dry clean, Do NOT Iron.

*Warranty Information: All products are designed to provide the user with a cost-effective and durable product. Standard warranty is a 'one year parts and labor' warranty which warrants product against defects in material and workmanship. It does not cover damage due to accidents, abuse, or normal wear and tear. Products found to be defective will be replaced or repaired at factory's discretion.*