

# Portable Popup Bar Large

## PBFL301-B

The Portable Popup Bar is a portable, wheeled sampling and serving station perfect for any event. The pre-assembled aluminium frame comes together by unfolding the legs, and inserting the interior shelf panels. Fully-customized graphics and printed top will win visitors over as you provide an effortless serving experience.



We are continually improving and modifying our product range and reserve the right to vary the specifications without prior notice. All dimensions and weights quoted are approximate and we accept no responsibility for variance. E&OE. See Graphic Templates for graphic bleed specifications.

## features and benefits:

- Portable, pre-assembled aluminium frame
- Zipper-enclosed storage space
- Printable graphics available
- Locking wheel casters
- Kit includes frame, four shelves, and a carry bag
- 1 year hardware warranty against manufacturer defects

## dimensions:

Hardware	Shipping
<p>Assembled unit: 40.13" w x 36.5" h x 20.06" d 1020mm(w) x 928mm(h) x 510mm(d)</p> <p>Approximate weight: 26 lbs / 12 kg</p>	<p>Packing case(s): 1 Carry bag</p> <p>Shipping dimensions: 41" l x 21" h x 7" d 1042mm(l) x 534mm(h) x 178mm(d)</p> <p>Approximate total shipping weight: 30 lbs / 14 kg</p>
<p>Graphic</p> <p>Refer to related graphic template for more information.</p> <p>Visit: <a href="http://www.exhibitors-handbook.com/graphic-templates">www.exhibitors-handbook.com/graphic-templates</a></p>	<p><b>additional information:</b></p> <p>Graphic material: Oxford</p> <p>Shelves are shipped inside the Popup Bar on the bottom level.</p> <p>When included in a larger kit, a different packaging solution will be listed to accommodate all contents of the kit. Individual packaging no longer provided.</p>

# Included In Your Kit

Tools, Components, & Connectors

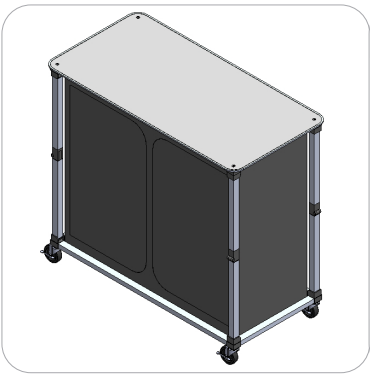

Large Portable Popup Bar x1

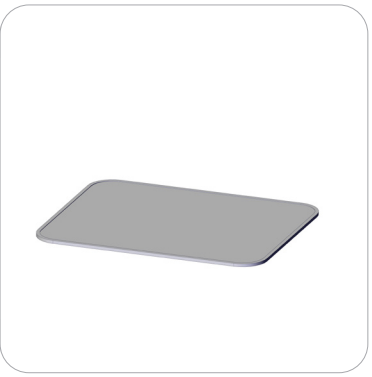

SHELF x4

# Kit Assembly

## Step by Step

### Step 1.

Unfold and lock legs.

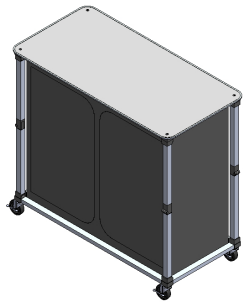

### Step 2.

Unzip and insert shelves.

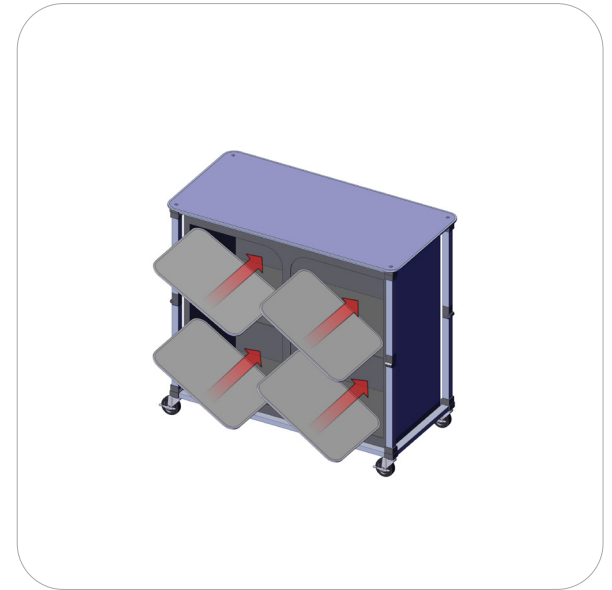
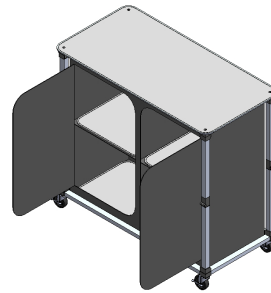

### Step 3.

Zip door to close or roll up velcro to stay open.

If graphics have been purchased move on to step 4, otherwise Set-up is complete.

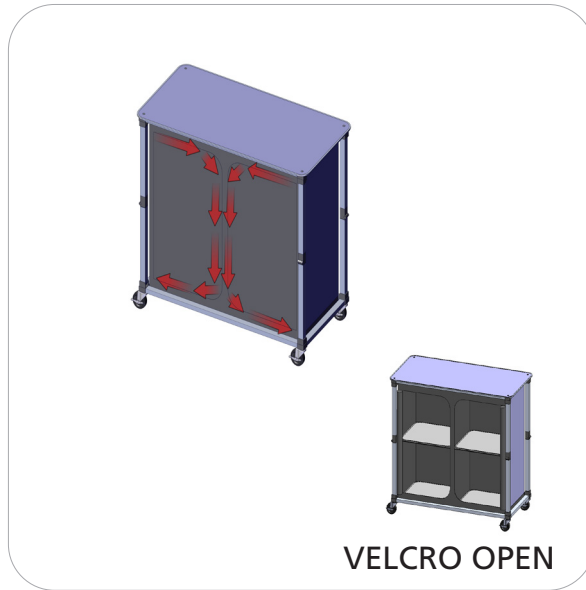
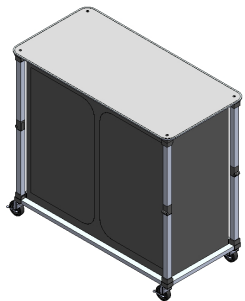

### Step 4.

Apply graphics by pressing the sides of the graphics onto the counter, making sure the velcro bands are aligned with one another.

Set-up is complete

