

# Formulate 10' Vertical Curve - Kit 11

## FMLT-WV10-11

Formulate™ is a collection of sophisticated, ergonomically designed exhibit booths. Formulate combines state-of-the-art zipper pillowcase dye-sublimated fabric coverings with advanced lightweight aluminum structures to provide unique design, functionality, and style. The excellence of the Formulate line of displays, hanging structures and products is simply unmatched. Stretch fabric graphics are hand-sewn, durable and dry-cleanable.



## features and benefits:

- State-of-the-art 30mm aluminum tube frame with snap button assembly
- Easy to store and ship
- Quick to set up
- Kit includes: one frame, one dye-sublimated pillowcase zipper graphic, stand-off pillowcase graphic ladder, and one wheeled molded OCL storage case
- Lifetime hardware warranty against manufacturer defects

## dimensions:

Hardware	Graphic
<p>Assembled unit: 114.1" w x 92.7" h x 38.1" d</p> <p>Stand-off pillowcase graphic ladder: 23.6" w x 92.7" h x 17.7" d</p> <p>Approximate weight (includes graphics): 36.63 lbs / 16.6 kgs</p>	<p>Refer to related graphic template for more information.</p> <p>Visit: <a href="http://www.exhibitors-handbook.com/graphic-templates">www.exhibitors-handbook.com/graphic-templates</a></p>
Shipping	
<p>Shipping dimensions: One OCL case: 52" l x 29" h x 15" d</p> <p>Approximate shipping weight (with case): 56.63 lbs / 25.7 kgs</p>	

## additional information:

Graphic material:  
Dye-sublimated zipper pillowcase fabric

Optional Accessories:  
Lumina 8-50 watt halogen lighting, literature pocket, stand-off graphic shelf, graphic header, larger freight cases



[www.display-setup-animations.com](http://www.display-setup-animations.com)

We are continually improving and modifying our product range and reserve the right to vary the specifications without prior notice. All dimensions and weights quoted are approximate and we accept no responsibility for variance. E&OE. See Graphic Templates for graphic bleed specifications.

Parts Included		
Part Label	Qty	Part Code
FABRIC GRAPHIC	x1	WV10-01-G
LN114 BOLT	x2	LN114 BOLT
90 DEGREE ELBOW JOINT FOR 30MM TUBING	x2	TC-30-90
1270MM X 30MM TUBE	x6	WV10-01-T1
30MM CURVED TUBE WITH PART T AND 90B LEFT SIDE	x1	WV10-01-T2-L
30MM CURVED TUBE WITH PART T AND 90B RIGHT SIDE	x1	WV10-01-T2-R
R2250 (1163MM ARC) CURVED TUBE	x4	WV10-01-T2
(2) 128MM TUBES SWAGED WITH PART TC-30-T	x1	WV10-01-T4
(2) 128MM TUBES SWAGED WITH PART TC-30-T	x1	WV10-01-T7
(2) 128MM TUBES SWAGED WITH PART TC-30-X	x1	WV10-01-T5
STEEL PLATE FOR WVC	x2	WVC-PLATE-STD

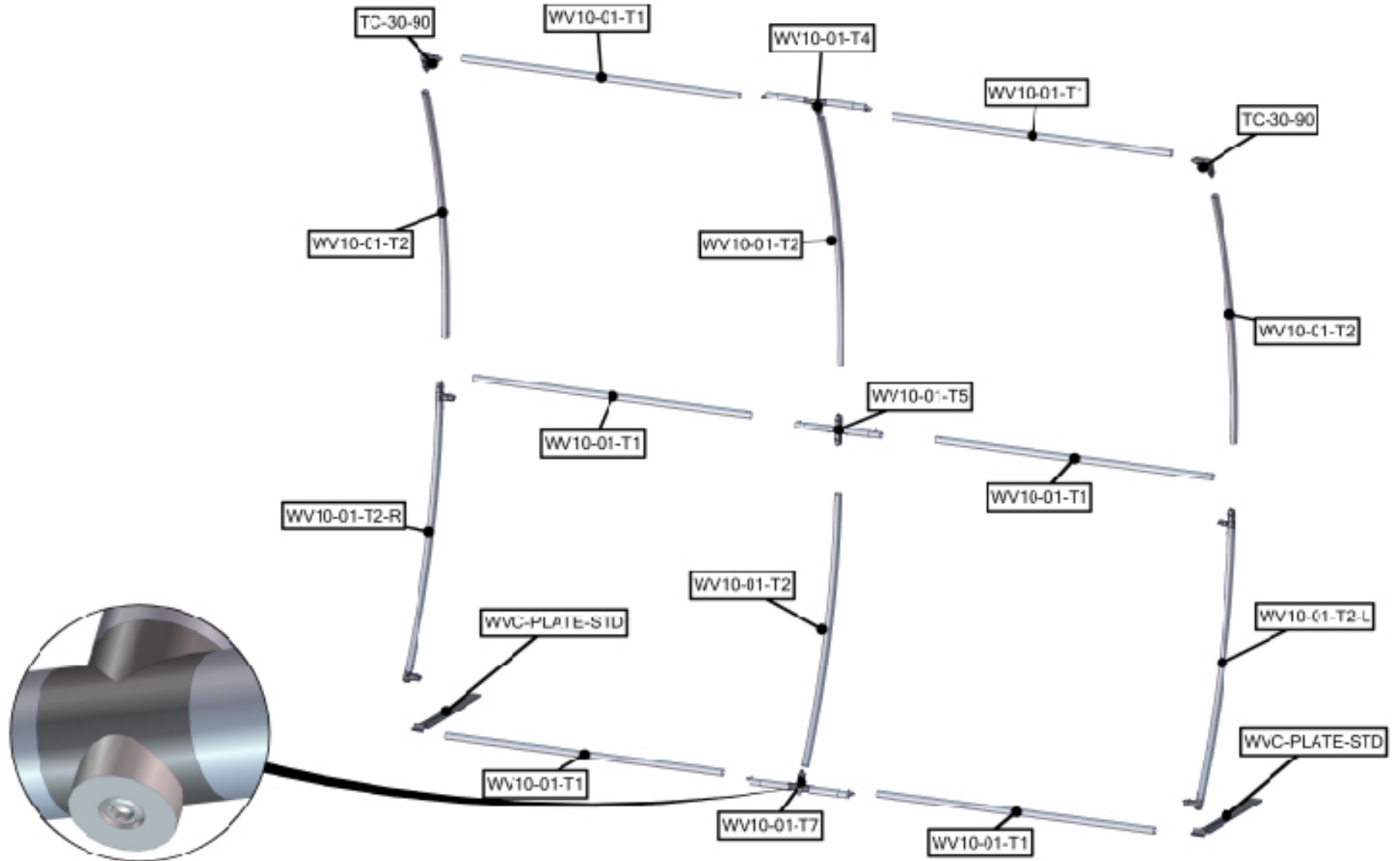

### Parts Included – Ladder

Part Label	Qty	Part Code
FABRIC PILLOWCASE GRAPHIC	x1	WL01-G
PARALLEL TUBE CLAMP FOR 30MM TUBES	x2	TCP3030
535MM X 30MM TUBE WITH PART TC-30-T BOTH ENDS	x1	WL01-T1
535MM X 30MM TUBE WITH (2) TC-30-90T	x2	WL01-T2
R2000MM X 30MM TUBE (97MM ARC)	x4	WL01-T3

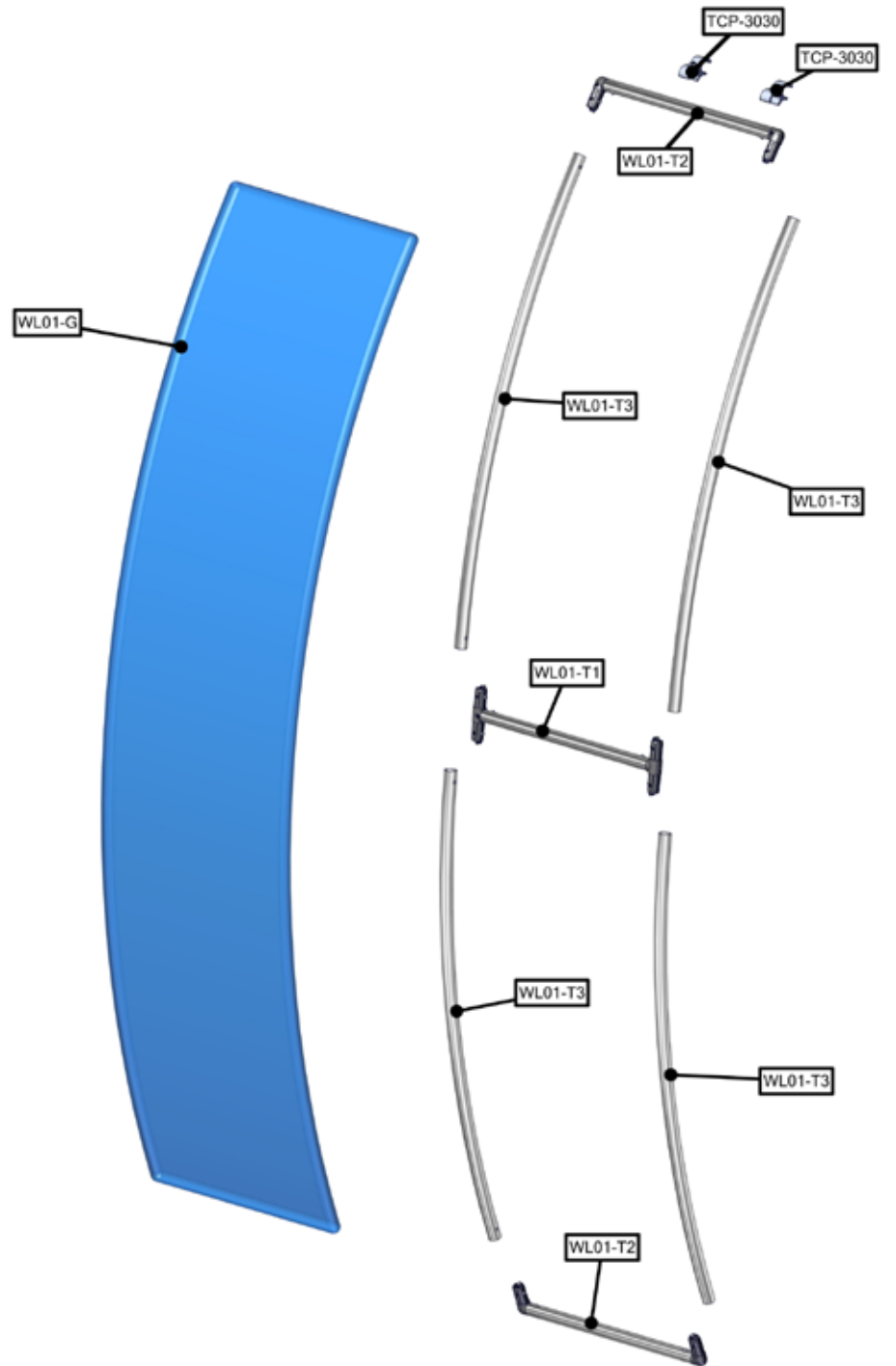

### STEP 1: ASSEMBLE FRAME

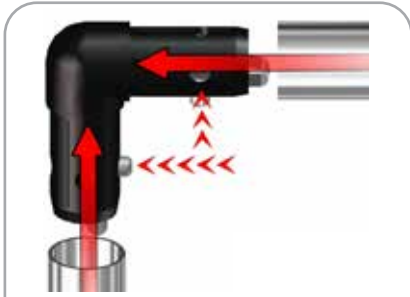

Assemble top frame corners using TC-30-90. Label codes will be on backside of tube. It is best to assemble frame laying flat.

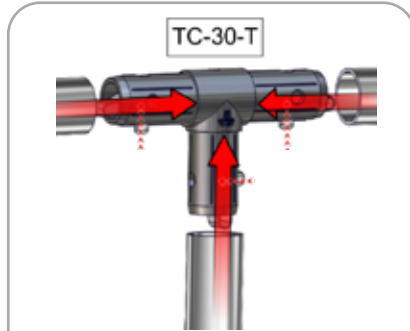

Connect sides of frame by lining up holes with snap buttons.



Use TC-30-90B to connect bottom frame corners; snap on button.

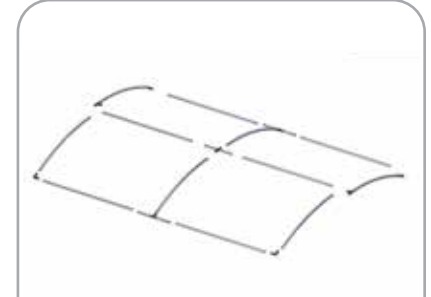

Frame assembly is complete once all sides and middle are connected.

### STEP 2: ATTACH FEET

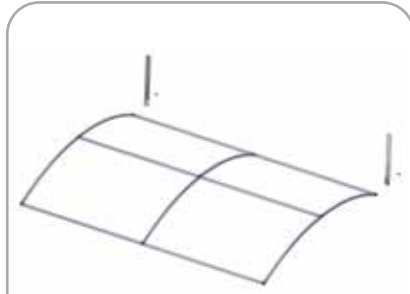

Attach feet with Allen key. See next step for detailed view.

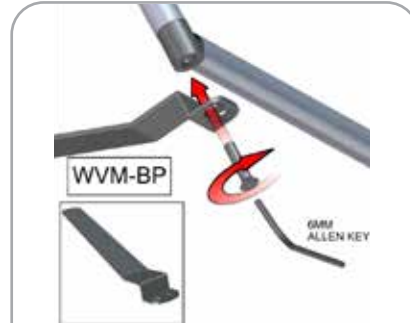

Using provided allen key, secure both feet (WVM-BP) to bottom of frame by tightening bolt.

### STEP 3: ATTACH GRAPHIC

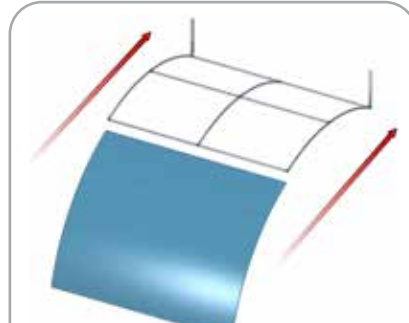

Slide graphic over top of frame.

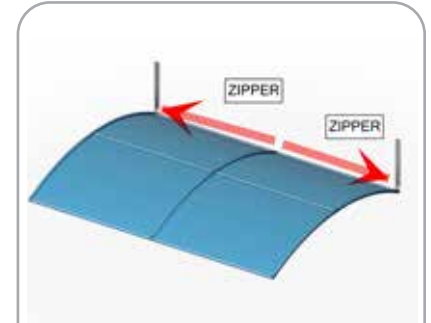

Zip fabric closed as shown along bottom.

### STEP 4: ASSEMBLE LADDER FRAME

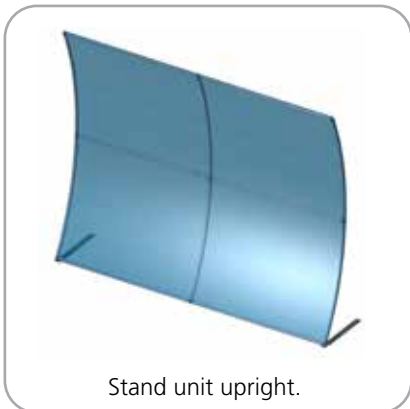

Stand unit upright.

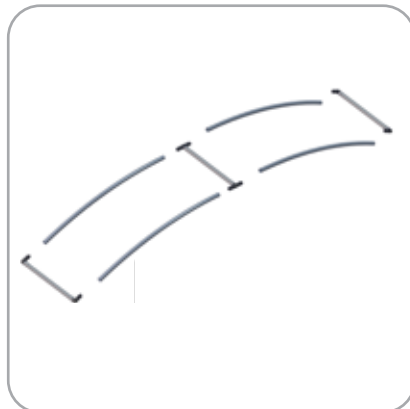

Connect bottom and top tubes to side tubes following the labels.

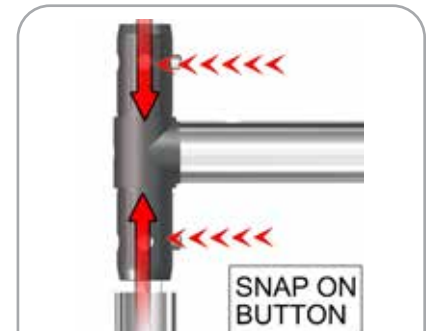

Then connect WL01-T1 middle spreader to sides.

### STEP 5: ATTACH GRAPHICS

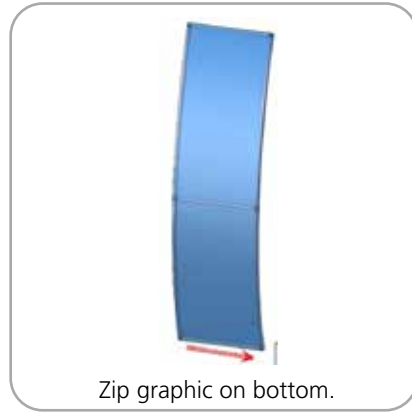
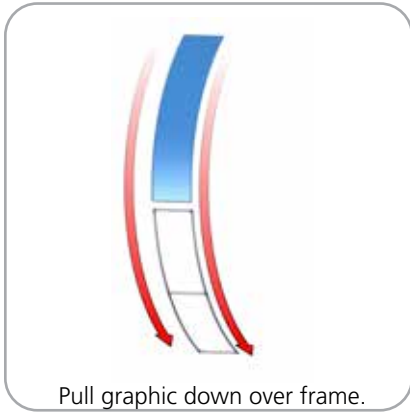

### STEP 6: ATTACH TO BACKWALL WITH CLAMPS

