

INSTRUCTIONS SOLO PRONTO POST 22"-32"

PARTS

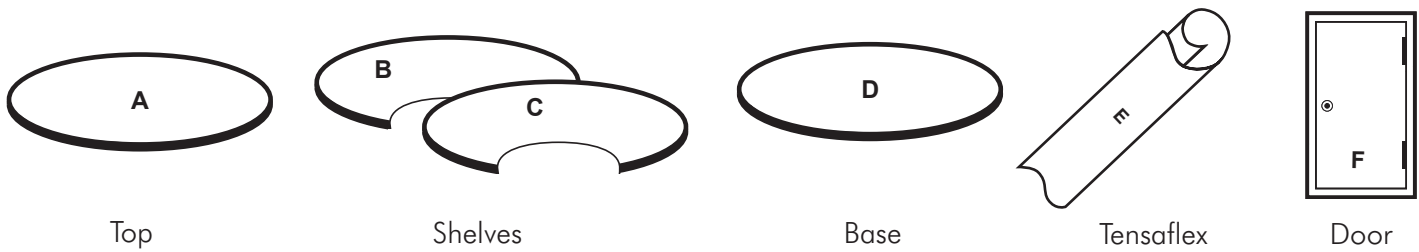

INSTRUCTIONS

Step 1

Place the base (D) at the site of display, unwind the tensaflex (E) and stretch out. Place the tensaflex along the reference dots, with arrows pointing up.

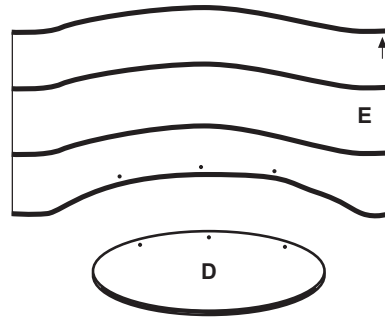

Step 2

Attach the base velcro (D) to the tensaflex velcro (E). Leave one of the ends loose.

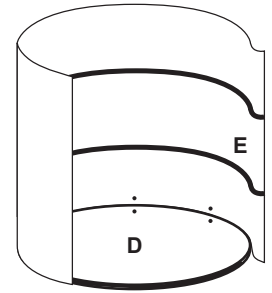

Step 3

Set shelf (C) in the corresponding place indicated by the velcro (take reference points into account).

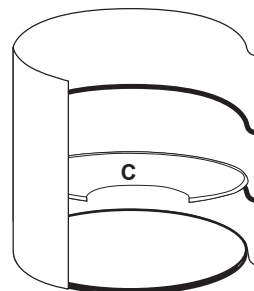

Step 4

Set shelf (B) in the corresponding place indicated by the velcro while centering and adjusting the tensaflex (E) simultaneously (take reference points into account).

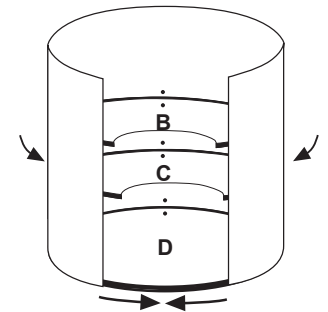

Step 5

Place top (A) and press the two velcro faces together. Make sure that each of the elements is in perfect position taking the reference dots into account.

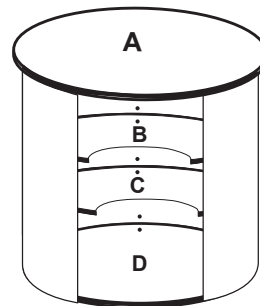

Step 6

Door Installation Detach the tensaflex, two inches from each side of the tops and shelves as shown in the figure. Place the door (F) in the corresponding space, open it and press the door frame velcro against the tensaflex velcro (E).

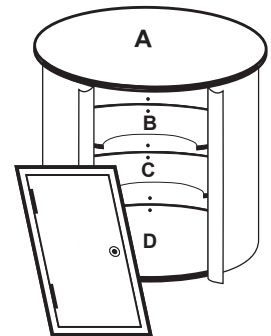

Note: To disassemble, reverse the steps.

INSTRUCTIONS SOLO PRONTO POST 22"-32"

1/2012

PARTS

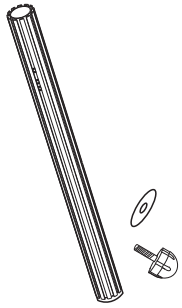

Post 0.87m with ProntoPost accessory

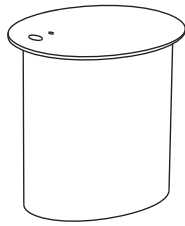

SOLO STANDARD with Post and grommet hole



Screen Support

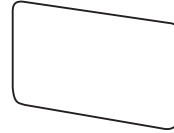

Header
19.69" (500mm)
x11.81" (300mm)

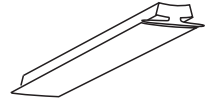

Header Support

ASSEMBLY

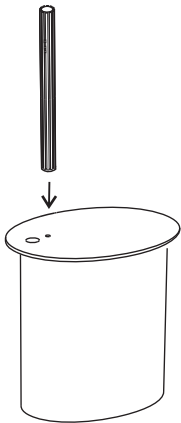

Step 1 Post

Place the post on the lid of the SOLO, from the underside, screw the post inserting the plastic screw and washer.

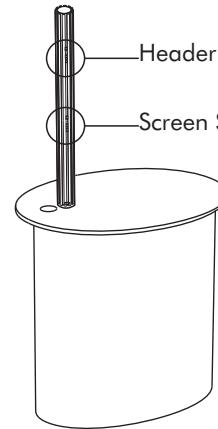
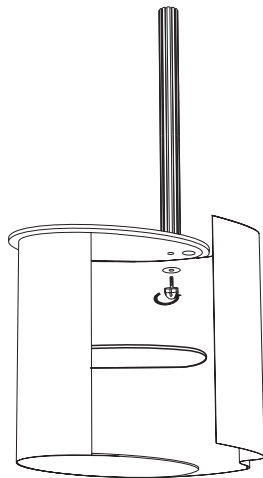

Step 2

Look for the guides on the post.

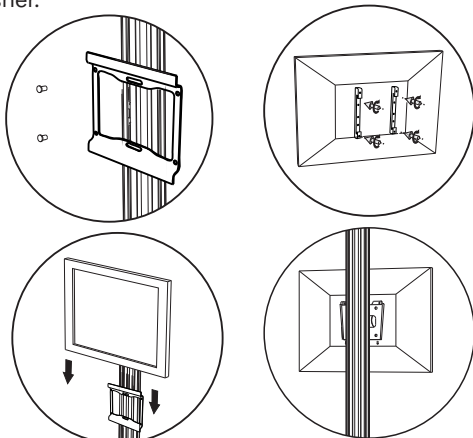

Step 3 Screen support

Screw the base of the screen support to the guide in the post. Screw the other part to the screen. Join together as shown in the picture.

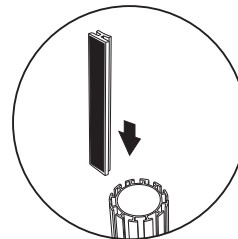
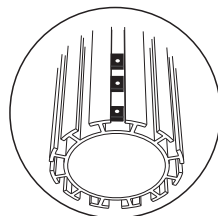

Step 4 Header

Slide the header support until it hits the guide inserted in the post. Attach the header pressing firmly on the velcro.

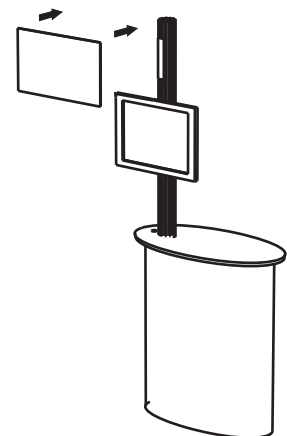

tradeshow-stuff.com
your source for everything tradeshow

estore.tradeshow-stuff.com

US Patent: 10/518,476
Colombian Patent: 02-054.774
Australian Patent: 2003242928

Brazilian Patent: PI03121968-4
European Community Patent: 03760840.3
Mexican Patent: Pa/a/2005/000032, No 254022