

Formulate Designer Series 30' Backwall - Kit 03

FMLT-DS-30-03

Formulate™ Designer Series 30ft displays have unique stylistic features and shapes, are portable and easy to assemble. The aluminum tube frame features snap-buttons and/or spigot connections and zipper pillowcase fabric graphics. All displays come in portable, wheeled transit cases. Simply pull the pillowcase fabric graphic(s) over the frame and zip.



features and benefits:

- Premium aluminum tube frames with snap button/ spigot assembly
- Horizontal curved shaped frame
- Easy to store and ship
- Quick to set up
- Weighted feet for added stability
- Zipper pillowcase fabric graphic
- Lifetime limited hardware warranty against manufacturer defects

dimensions:

Hardware

Graphic

Assembled unit:

349.24" w x 92" h x 37.62" d
8871mm(w) x 2337mm(h) x 956mm(d)

Refer to related graphic template for more information.

Approximate weight with cases:
124 lbs / 56.2 kgs

Visit:
www.exhibitors-handbook.com/graphic-templates

Shipping

Packing case(s):
2 OCE Cases

Shipping dimensions:

OCE: Expandable case length (l) may vary
40" - 66" l x 18" w x 18" h
1016mm-1677mm(l) x 458mm(w) x 458mm(h)

Approximate total shipping weight
(includes cases & graphics):
155 lbs / 70.3 kgs

additional information:

Graphic material:
dye-sublimation zipper pillowcase fabric

We are continually improving and modifying our product range and reserve the right to vary the specifications without prior notice. All dimensions and weights quoted are approximate and we accept no responsibility for variance. E&OE. See Graphic Templates for graphic bleed specifications.

Included In Your Kit

Tools, Components,
& Connectors



ALLEN KEY SET x1



ES50 x12



TC-30-S x4





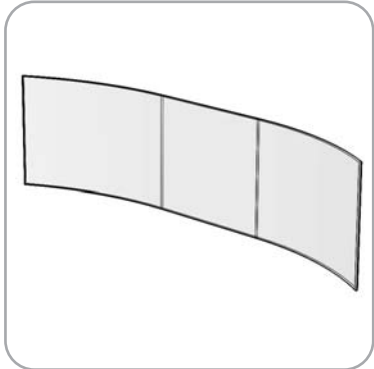

ES50-2W x4

Graphics



FMLT-DS-30-03-G x1

Included In Your Kit

Tubes					
	DS-30-03-T1 x4	DS-30-03-T2 x4	DS-30-03-T3 x4	DS-30-03-T4 x8	DS-30-03-T5 x4

Exploded View

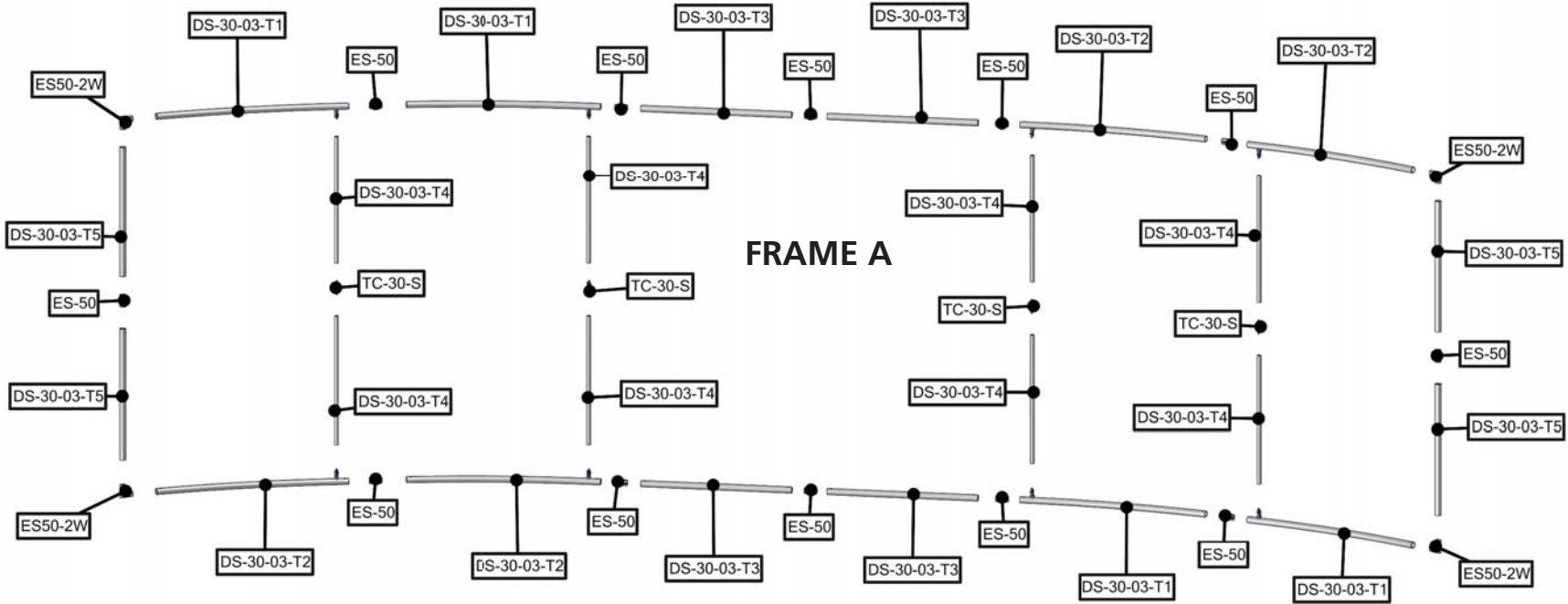

Labeling Diagram

FMLT-DS-30-03

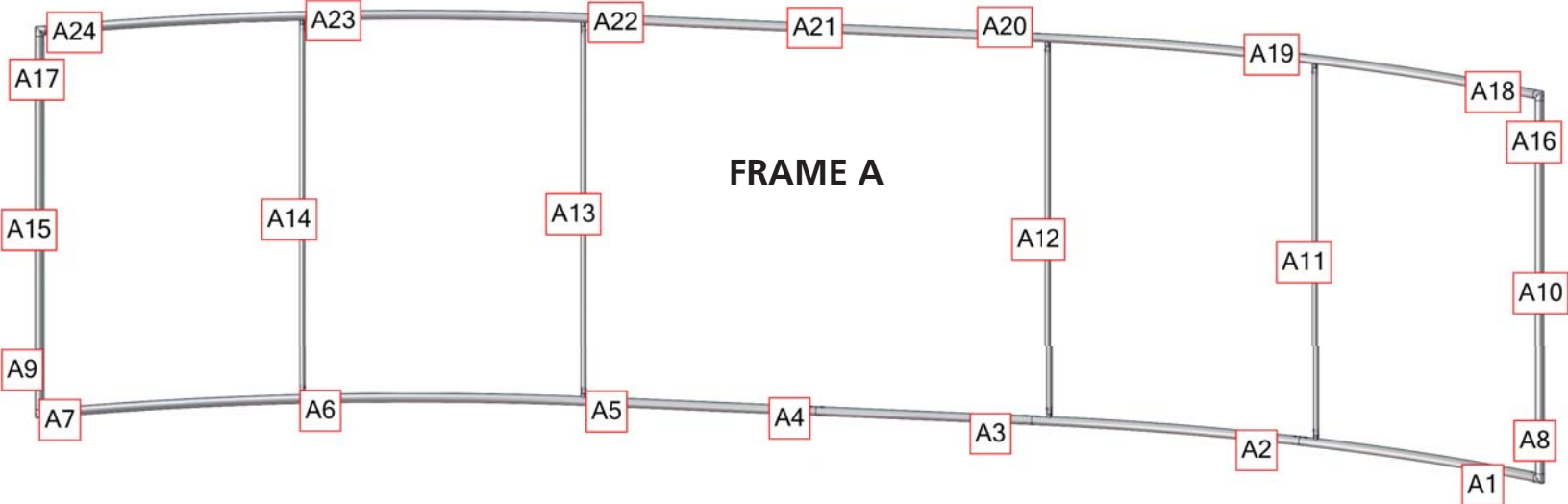

OVERHEAD VIEW

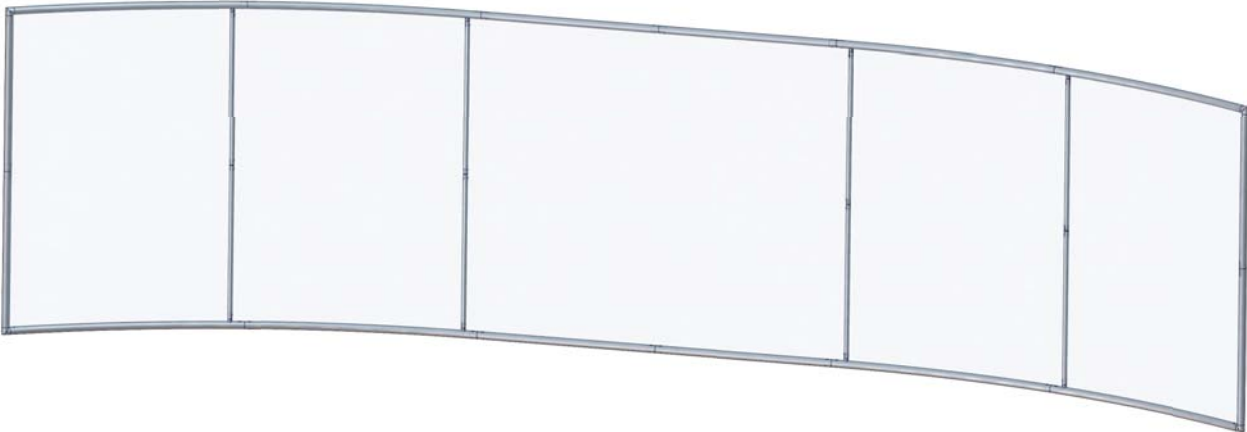

Connection Methods

Formulate™ structures use a number of different yet simple connection methods. Your kit will include one or more of the connection methods shown below. Steps within the Kit Assembly will reference a specific method for each connection point.

Connection Method 1: ES30 / ES50 / ES75

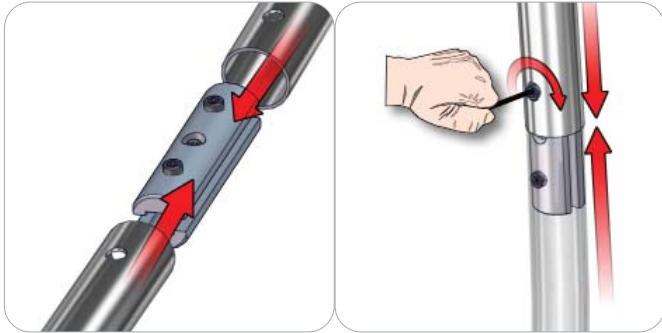

Compress the unlocked connector and slide one tube onto each end. Lock both screws carefully using your allen key tool. Be sure to lock securely, but do not overtighten.

Connection Method 2: Snap Buttons & Swage

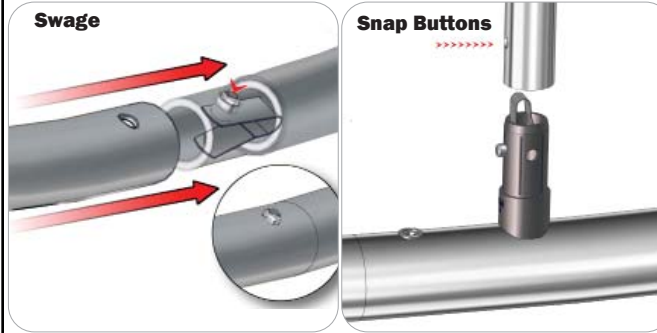

Locate the snap button on the connector or swage tube. Locate the hole on the corresponding tube. Press the snap button with your thumb and slide the tube and connector together so that the snap button snaps fully into the lock hole. To disassemble, press the snap button and pull apart.

Connection Method 3: ES30-90B / ES30-I / ES30-C

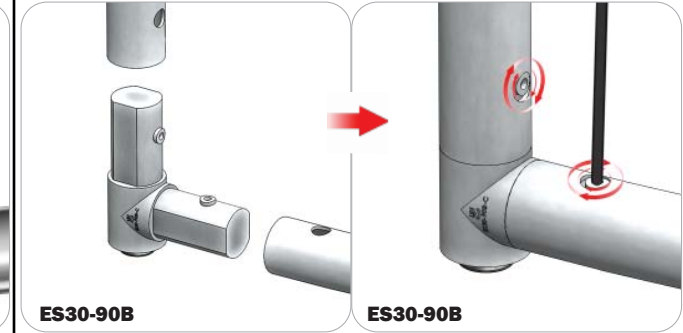

Compress one unlocked end of the connector and slide it through one tube end. Compress the other end of the connector and slide the second tube on. Lock both screws carefully using your allen key tool. Be sure to lock securely, but do not overtighten.

Connection Method 4: Tube Clamps

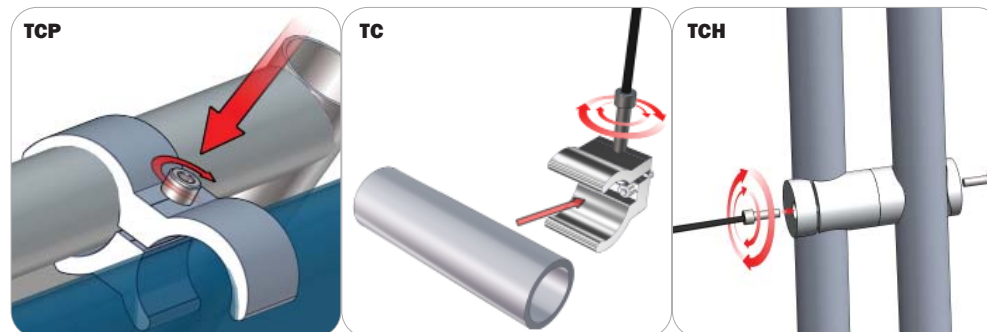

Be sure to fully assemble all frames before using clamps. With the clamp unlocked, place one tube of the first frame into the mouth of the clamp. Place the second tube (if applicable) into the second mouth of the clamp. With both frame's tubes in the clamp, be sure to lock securely, but do not overtighten.

Kit Assembly

Step by Step

Step 1.

Assemble the bottom horizontal 50mm tube section. Using the provided allen key set, start attaching the ES50 expanding spigots for the 50mm tubes.

Please reference Connection Method 1 for more details.

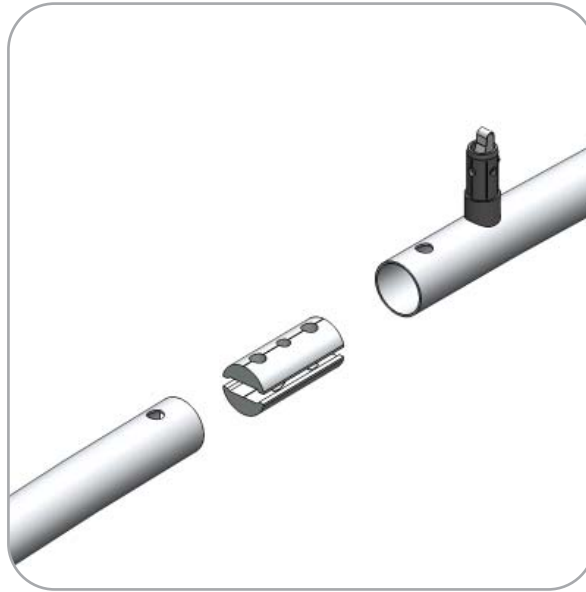

Step 2.

Continue assembling the bottom horizontal tube section. Using the provided allen key set, attach the corner spigots ES50-2W's on the left and right ends for the vertical 50mm tubes.

Please reference Connection Method 3 for more details.

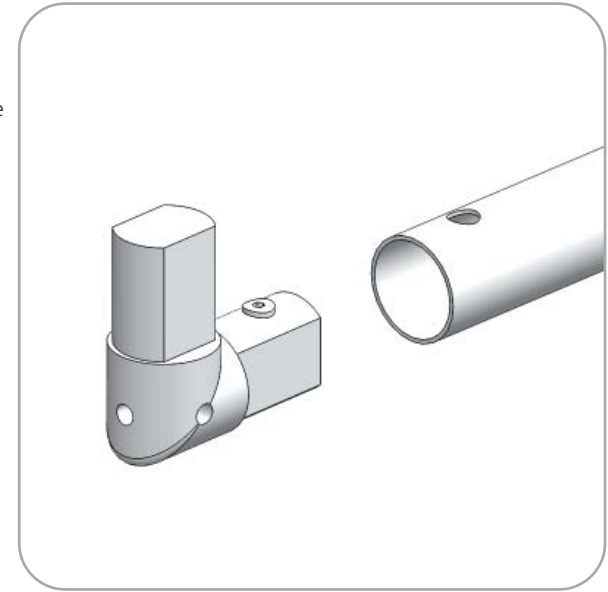

Step 3.

Using the provided allen key set, assemble the vertical 30mm and 50mm tube sections.

Please reference Connection Methods 1, 2 and 3 for more details.

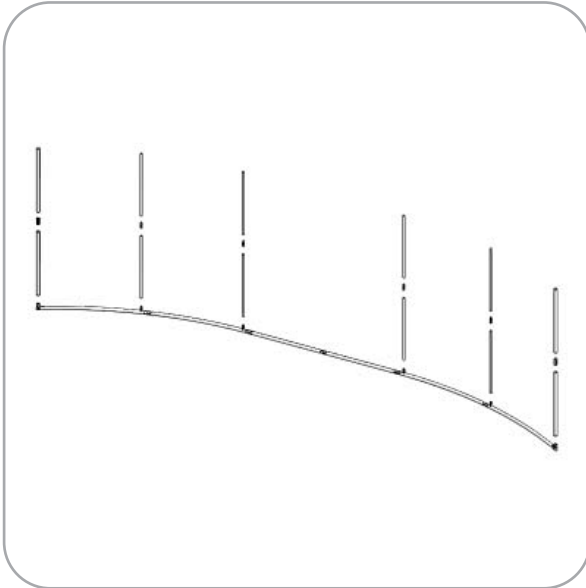

Step 4.

Using the provided allen key set, attach the two corner spigots ES50-2W's on the left and right ends of the vertical 50mm tubes.

Please reference Connection Method 3 for more details.

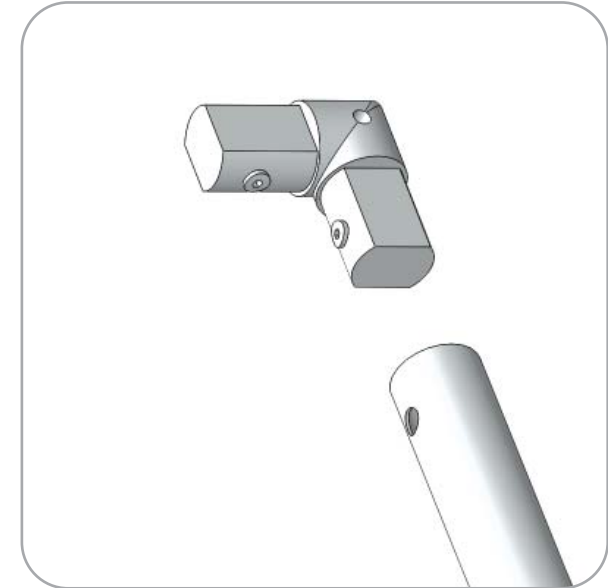

Kit Assembly

Step by Step

Step 5.

Using the provided allen key set, assemble the top horizontal 50mm tube section with ES50 expanding spigots.

Please reference Connection Method 1 for more details.

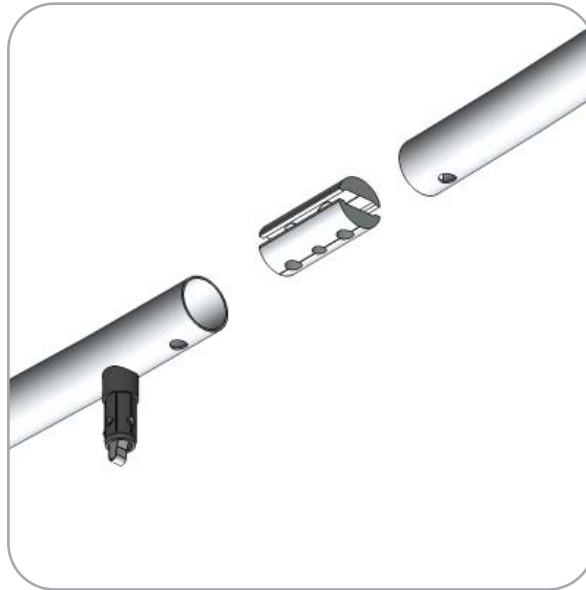
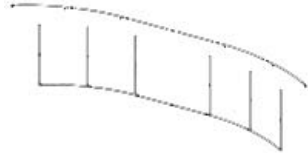

Step 7.

Locate the fabric cover for Frame A. With the frame flat on the floor, pull the cover over the top of the frame. Zip the fabric cover to enclose the frame.

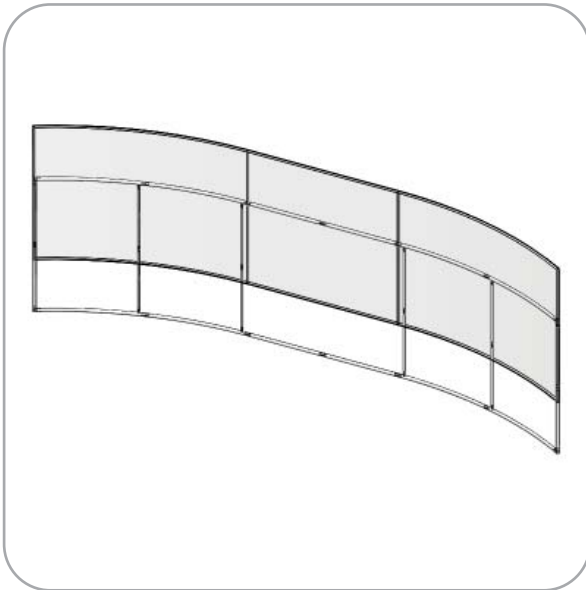
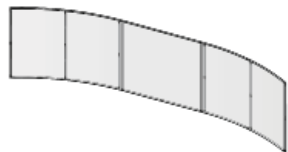

Step 6.

Using the provided allen key set, attach the top horizontal 50mm tube assembly. Attach each end to the corner ES50-2W spigots on the left and right vertical ends. Attach the plastic connectors to the 30mm vertical uprights.

Please reference Connection Methods 2 and 3 for more details.

